

The famous Mozart creative pixel, now in a Linear format!

3 to 48 DMX channels per fixture, based on settings 1, 4, or 16 "pixel" groups per fixture, based on settings. Extremely compact and lightweight.

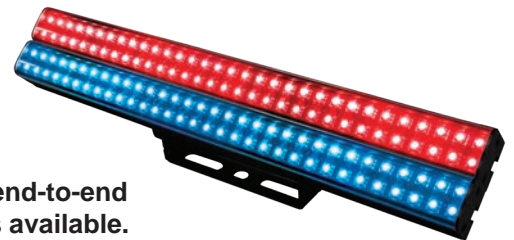

- Great for low weight load-bearing structures and surfaces
- Approx. 11,000 NITS! Brighter than nearly all outdoor LED walls!
- Ultra-high refresh rate – 38,400Hz! Great for high-speed photography and videography.
- Single cable, simple power-data connections, daisy-chain or split – easily place a Mozart almost anywhere
- Easy remote addressing and mode switching via RDM
- Joiner accessories and diffusion filter also available



Side-by-side and end-to-end
joiner accessories available.

Worldwide Exclusive Distribution

sales@tmb.com

Los Angeles
+1 818.899.8818

London
+44 (0)20.8574.9700



New York
+1 201.896.8600

Beijing
+86 10.8492.1587

Toronto
+1 519.538.0888

Specifications	
Part Number	SOLMOZARTLR
LED Light Sources	64 CREE®
Pixels per Fixture	1, 4, or 16
DMX Channels per Fixture	3, 12, or 48
Fixtures per Drive Output	10
Beam Spread	120°
Color LEDs	RGB
Average Color Wavelength (manufacturer rated)	Red: 625 nm
	Green: 530 nm
	Blue: 460 nm
Refresh Rate	38400 Hz
Intensity Control	16bit or 8bit
Control	DMX-512A, RDM
DC Power	48V
Power Consumption	20W
Cooling	Convection
IP Rating	IP40
Operating Temperature	-20°C to +40°C
Control/Power Connectors	In/Thru - Amphenol Sensor M12
Number of Fixtures per Mozart Drive Output	10 max.
Unit Dimensions (HxWxD)	1.3 x 15.2 x 1.3 in [33 x 386 x 33 mm]
Shipping Dimensions (HxWxD)	5 x 17 x 4 in [127 x 432 x 102]
Unit Weight	1.6 lb [0.73 kg]
Shipping Weight	2 lb [0.91 kg]

Ordering Codes	
Ordering Code	Item
SOLMOZARTLR	Mozart LR Linear Fixture
SOLMOZARTLRJL	Mozart LR Joiner, Linear
SOLMOZARTLRJ66	Mozart LR Joiner, 66.5 mm
SOLMOZARTLRJ99	Mozart LR Joiner, 99 mm
PPMO10PSUP	PortableMount 1-Output Drive
PPMO40PSU	RackMount 4-Output Drive
ZMOZEXT3P5	Solaris Mozart cable, IP68, 5 ft
ZMOZEXT3P10	Solaris Mozart cable, IP68, 10 ft
ZMOZEXT3P25	Solaris Mozart cable, IP68, 25 ft
ZMOZEXT3P50	Solaris Mozart cable, IP68, 50 ft
ZMOZEXT3P100	Solaris Mozart cable, IP68, 100 ft
PP2RMKITLS	2U RackMount Kit for PortableMount Drive

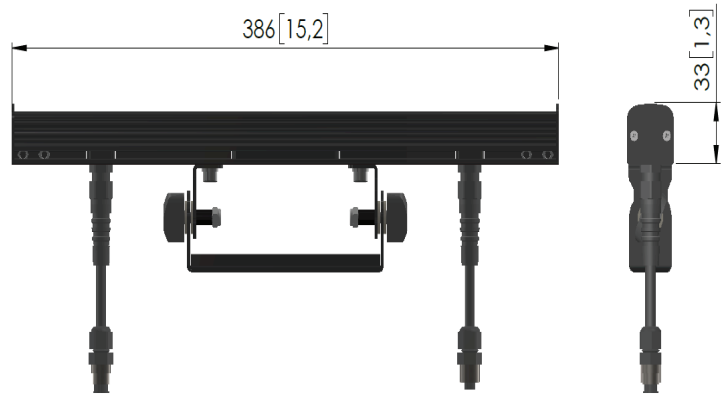

Dimensions in mm [inches]

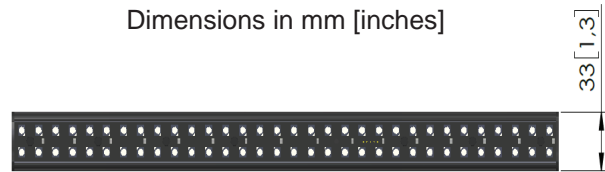

Mozart LR Linking Mounts

Mozart LR Joiner Linear

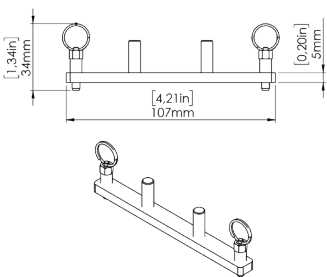

Mozart LR Joiner 66.5mm

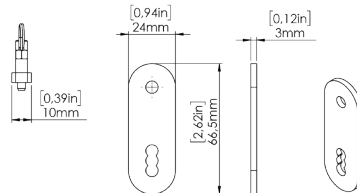

Mozart LR Joiner 99mm

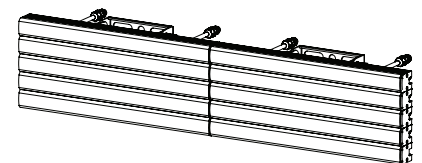
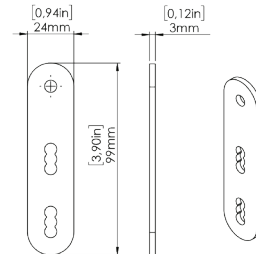

Unified power and control for all Solaris Mozart fixtures over a single cable



PortableMount 1-Output Drive
PPMO10PSUP



RackMount 4-Output Drive
PPMO40PSU

Specifications		
Model	PortableMount 1-Output	RackMount 4-Output
Part Number	PPMO10PSUP	PPMO40PSU
Number of Mozart fixtures connected	10 max. depending on fixture	40 max. 10 per output depending on fixture
Control Protocol	DMX 512A + RDM	DMX 512A + RDM, ArtNet, sACN (E1.31)
DMX Connectors	In/Thru - XLR 5-pin M/F	
Ethernet Connectors	N/A	2x Neutrik EtherCon RJ45
Power Input	100-240 VAC 50-60 Hz	
Power Consumption	200 W max.	1200 W max.
Power Connectors	PowerCon 20A IN/THRU	PowerCon 20A IN
DC Power Out	24 VDC	
Fixture Control/Power Connectors	1x Out - Amphenol Sensor M12	4x Out - Amphenol Sensor M12
Max. Fixture Cable Length	328 ft. [100 m] per output with fixtures at any interval.	
Cooling	Convection	Forced Air
Unit Dimensions (HxWxD)	4.7 x 8 x 10.7" [120 x 202 x 272 mm] with yoke 3.4 x 8 x 10.7" [87 x 202 x 272 mm] without yoke	19 x 3.5 x 12 in [482.6 x 88.1 x 304 mm]
Shipping Dimensions (HxWxD)	7.3 x 10.25 x 13.5" [186 x 261 x 343 mm]	20.75 x 7.5 x 15.75 in [527 x 191 x 400 mm]
Unit Weight	9.85 lb [4.46 kg]	17.25 lb [7.8 kg]
Shipping Weight	10.65 lb [4.82 kg]	19.10 lb [8.6 kg]



Worldwide Exclusive Distribution

sales@tmb.com

Los Angeles
+1 818.899.8818

London
+44 (0)20.8574.9700

tmb
www.tmb.com

New York
+1 201.896.8600

Beijing
+86 10.8492.1587

Toronto
+1 519.538.0888

CONTACT INFORMATION

LOS ANGELES HEADQUARTERS

527 Park Avenue | San Fernando, CA 91340, USA

Tel: +1 818.899.8818 | Fax: +1 818.899.8813

sales@tmb.com

TMB 24/7 TECH SUPPORT

US/Canada: +1.818.794.1286

Toll Free: 1.877.862.3833 (1.877.TMB.DUDE)

UK: +44 (0)20.8574.9739

Toll Free: 0800.652.5418

techsupport@tmb.com

LOS ANGELES +1 818.899.8818

LONDON +44 (0)20.8574.9700

NEW YORK +1 201.896.8600

BEIJING +86 10.8492.1587

CANADA +1 519.538.0888



A full service company providing technical support, customer service, and follow-up. Providing products and services for the industrial, entertainment, installation, defense, broadcast, research, telecommunications, and signage industries. Servicing the global market from offices in Los Angeles, London, New York, Toronto, and Beijing.